

THIS DRAWING SUPERSEDES
ALL PREVIOUS DRAWINGS FOR
7-11-01

NO:

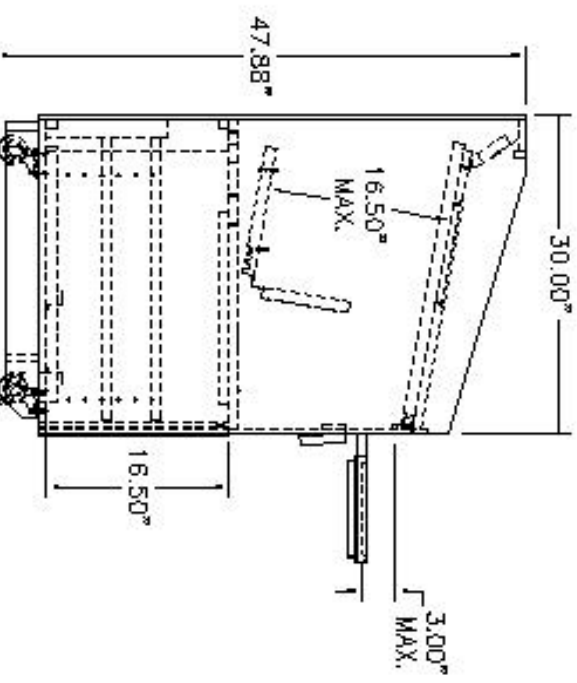
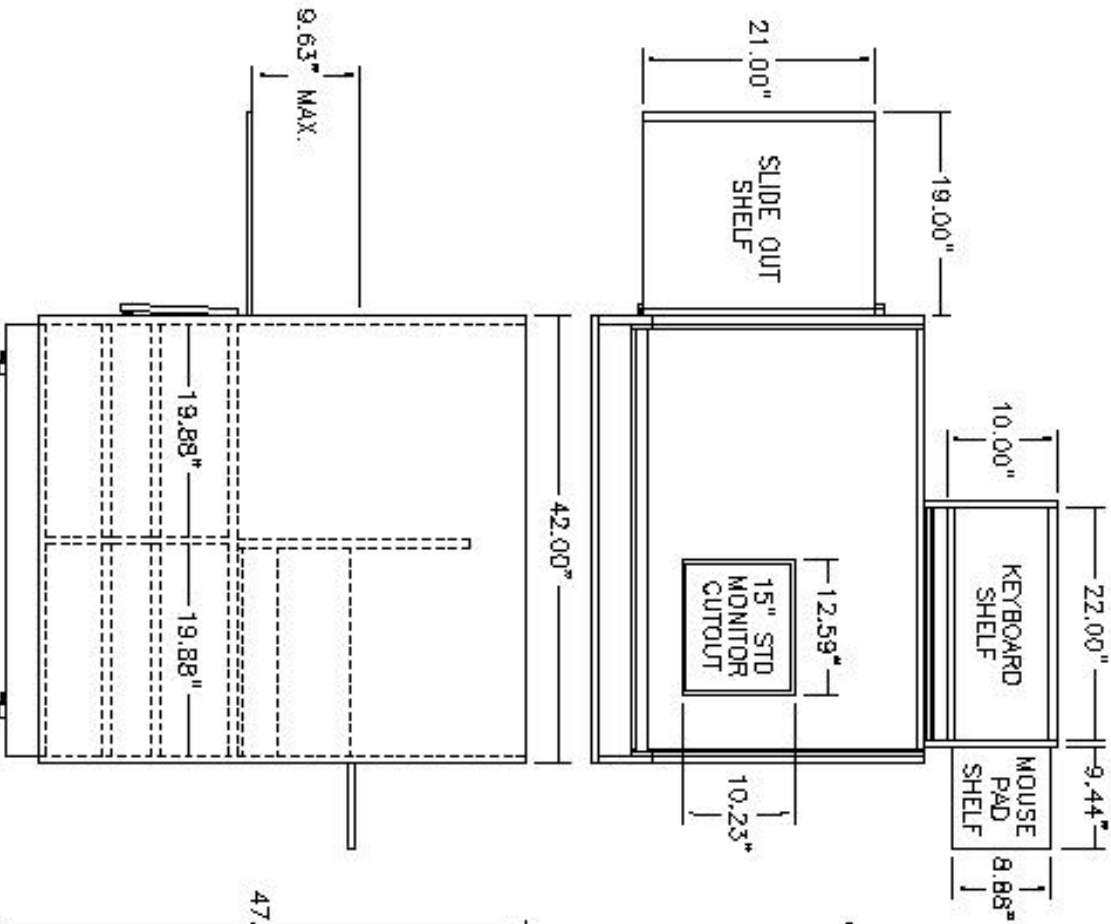
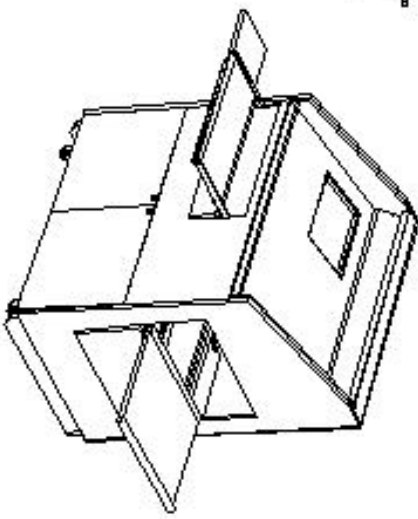

REVISION					
REMOVED BY:					
APP'D. BY:					

SCALE: 1=16	DRAWN BY: KULL	DATE: 7-11-01	APP'D. BY:	DATE:	SERWER
NAME: LEXINGTON 42" MULTI-MEDIA LECTERN					
DA-LITE SCREEN CO. INC. NO:					
WARRICK, INDIANA, USA					

THIS PRINT SUPERSEDES
ANY PRINT DRAWN FROM THE
7-11-01

NO:

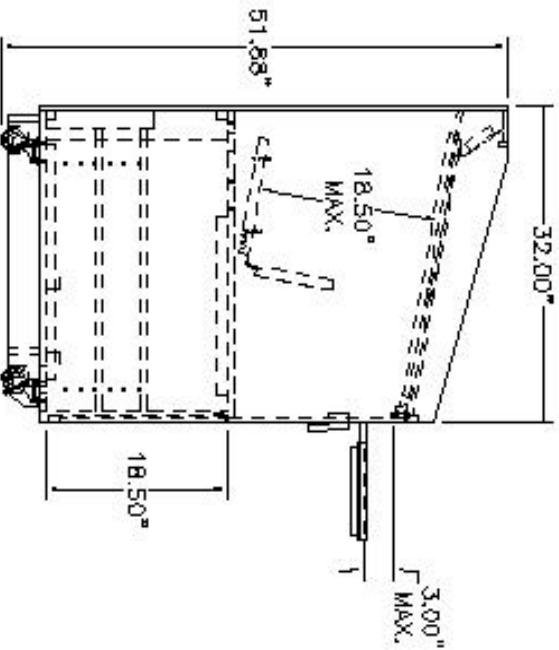
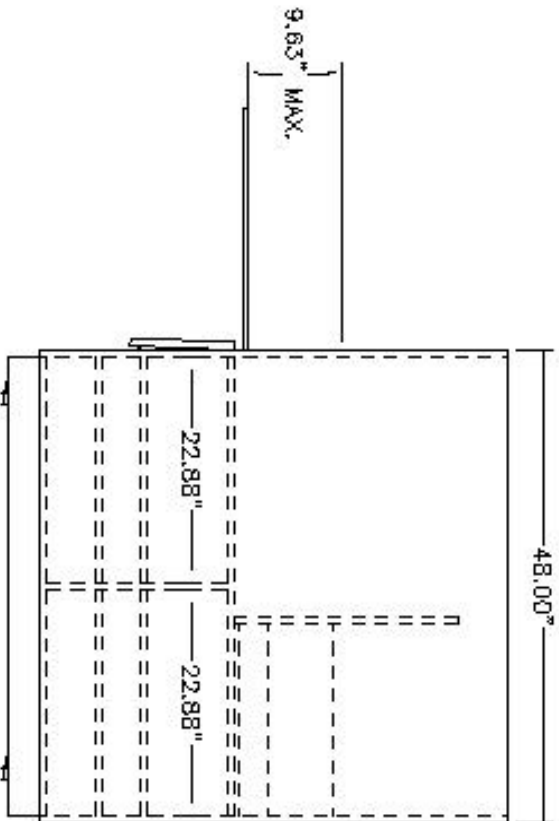
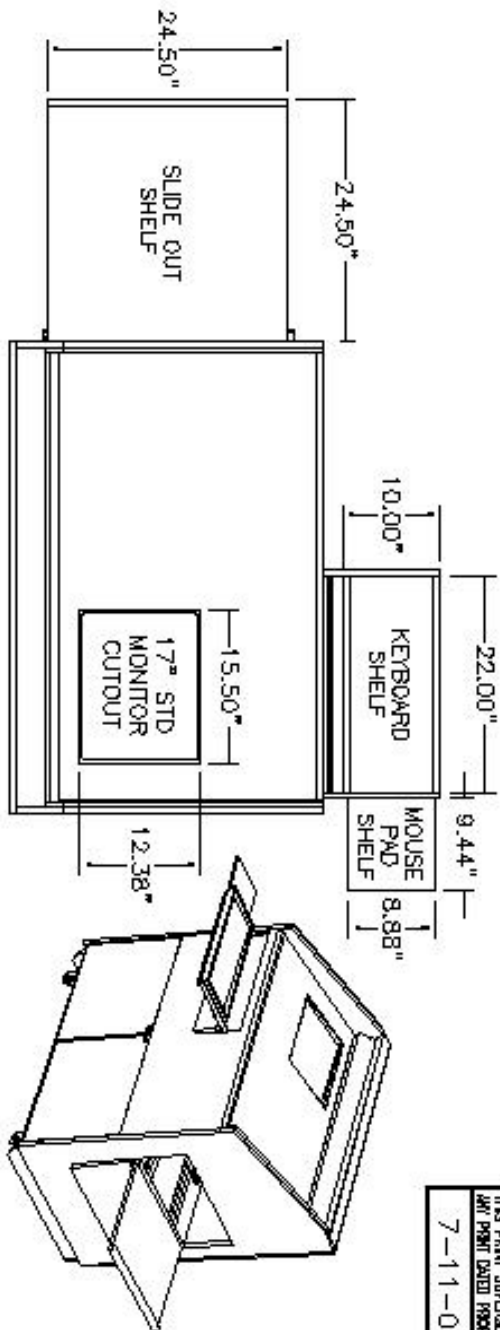

REVISION	APPROVED BY:	DATE:

TOLERANCES DECIMAL: .XX = ±.010 .XXX = ±.005 FRACTIONAL: = ±.015 ANGULAR: ± 1°		SCALE 1 = 18"	DRAWN BY: K.J.L.	DATE: 7-11-01	APPROVED BY:	DATE:
MATERIAL NO:		FINISH:		SERVER		
NAME LEXINGTON, 48" MULT-MEDIA LECTERN		DA-LITE SCREEN CO., NO:				
WARSAW, INDIANA, USA						

THIS PRINT SUPERSEDES: ND:
 AND PRINT DATED FROM THE
 10-10-02

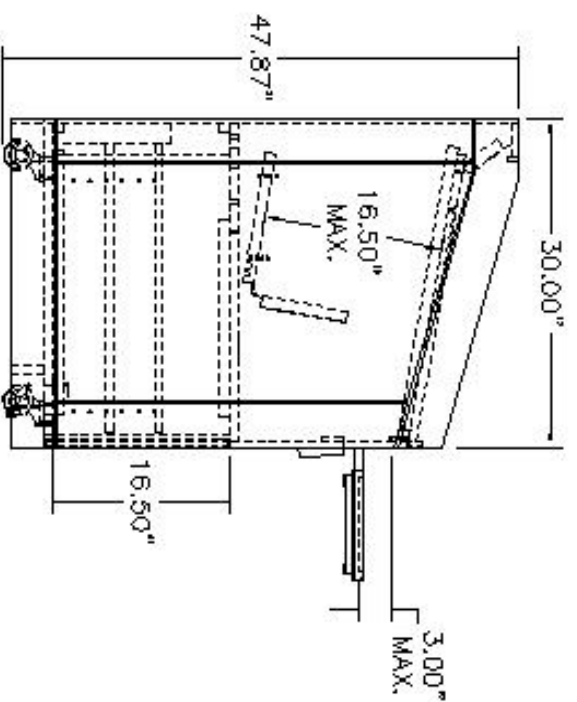
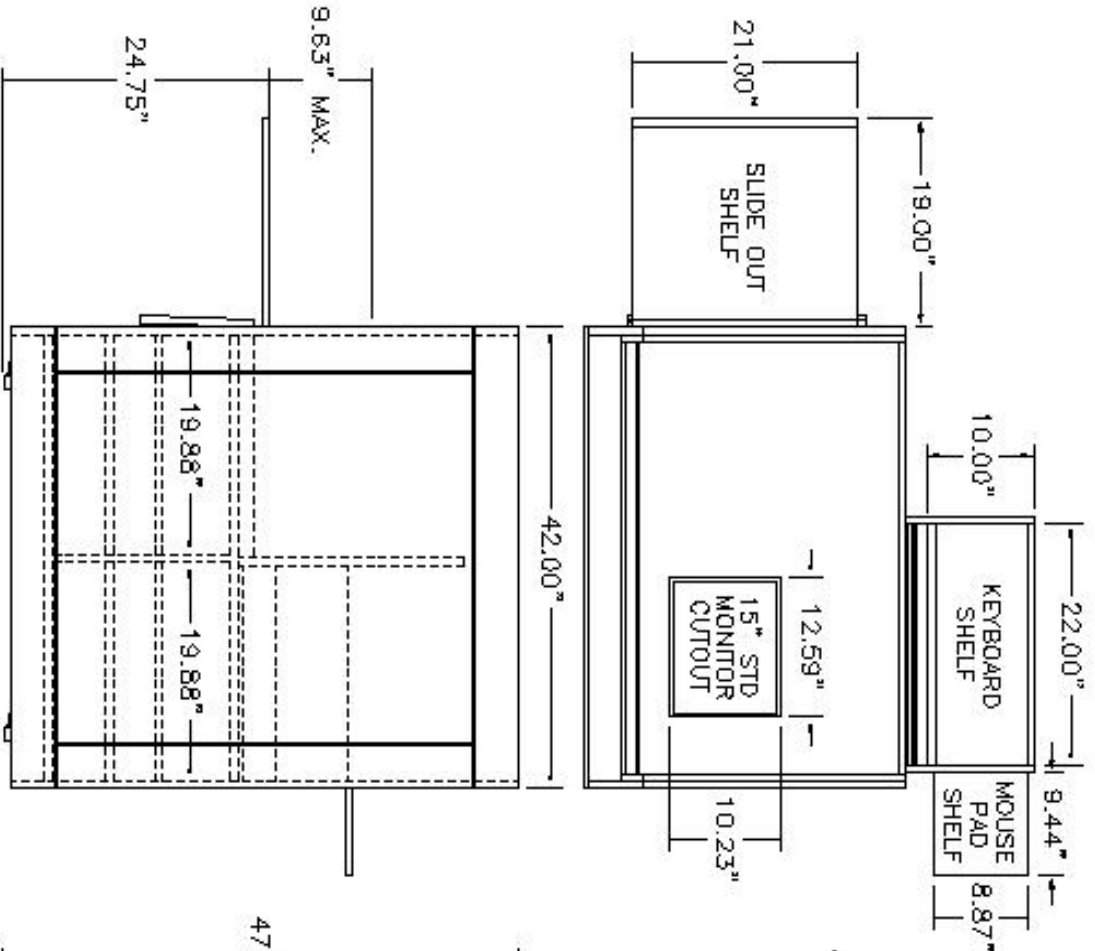
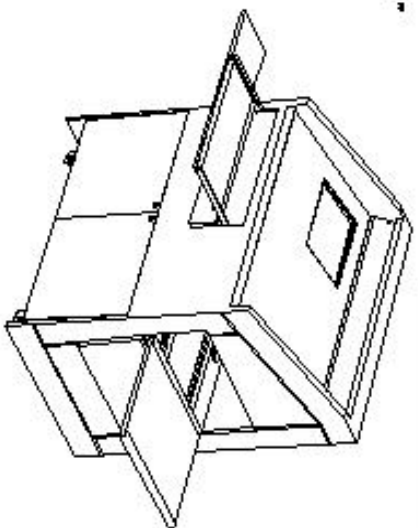

REVISION					
PREPARED BY:					
APP'D BY:					

SCALE: 1 = 16	DRAWN BY: K.J.L.	DATE: 10-10-02	APP'D BY:	DATE:	SERVER:
NAME: PROVIDENCE 42" MULTI-MEDIA LECTERN					
DA-LITE SCREEN CO. INC. ND:					
WABSAWI, INDIANA, USA					

THIS PRINT SUPERSEDES
 ANY PRINT DATED PRIOR TO
 10-10-02

NO:
 10-10-02

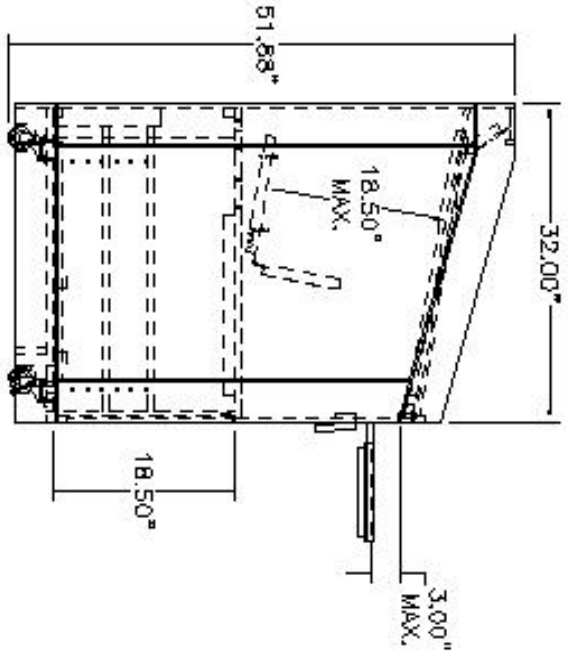
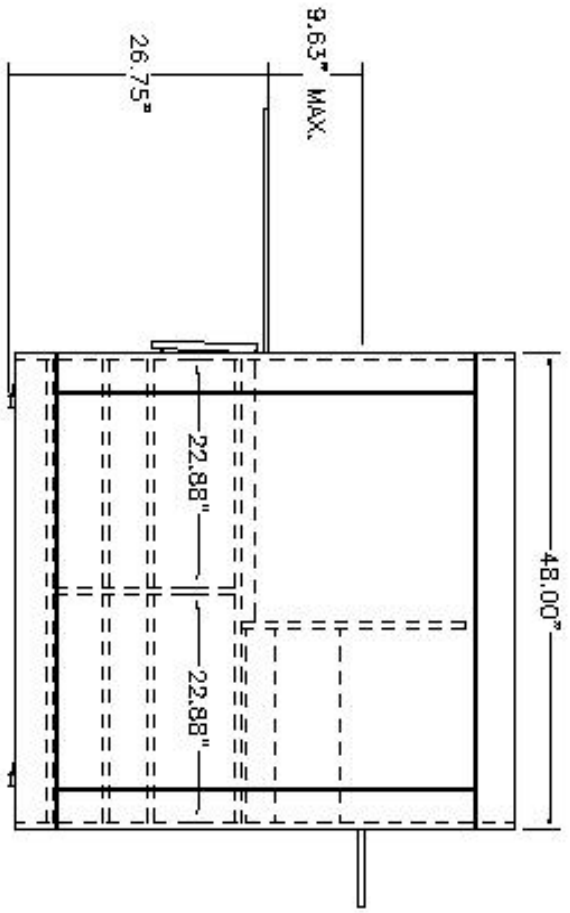
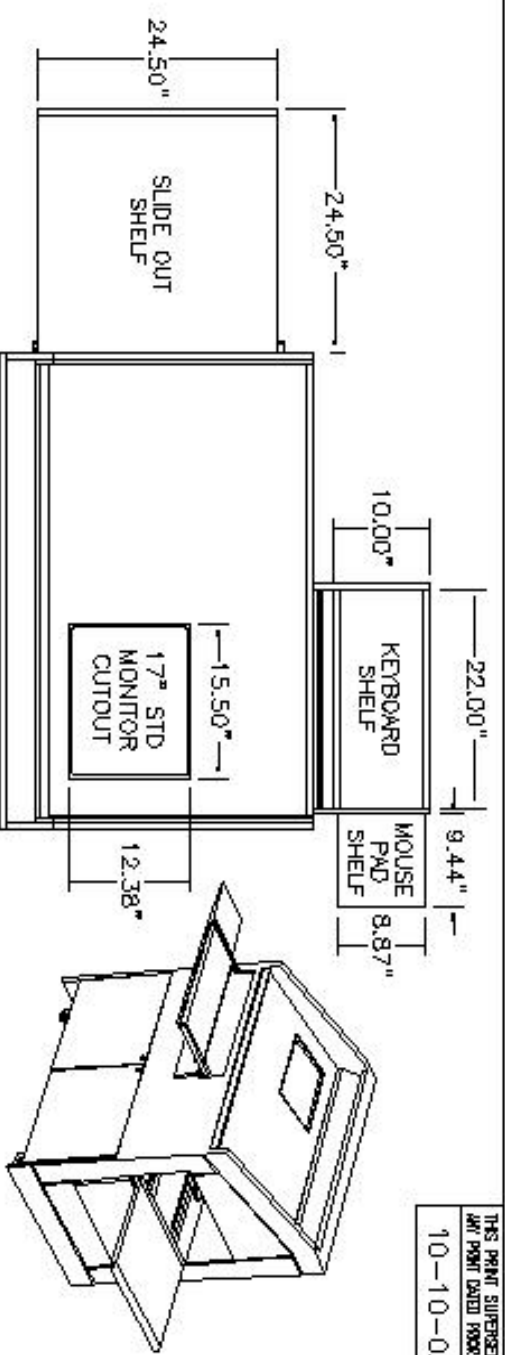

REVISION	APPROVED BY:	DATE:

SCALE: 1=18"	DRAWN BY: K.J.L.	DATE: 10-10-02	APP'D BY:	DATE:
MATERIAL NOS: N/A	FINISH: N/A			
NAME: PROVIDENCE, 48" MULTI-MEDIA LECTERN				
DA-LITE SCREEN CO., NO:				
WARSAW, INDIANA, USA				
				CAD

THIS PRINT SUPERSEDES
 ANY PRINT DATED PRIOR TO:
 4-24-06

NO:
 4-24-06

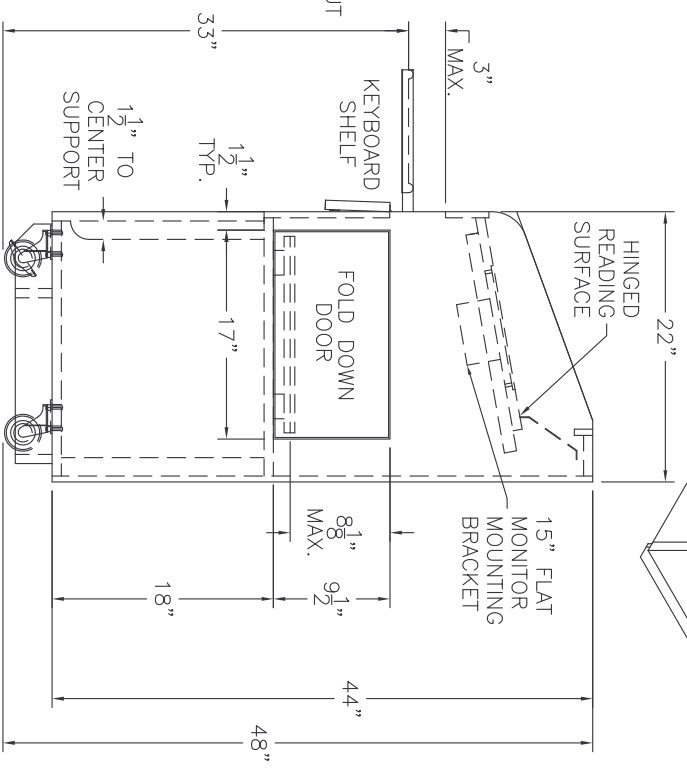
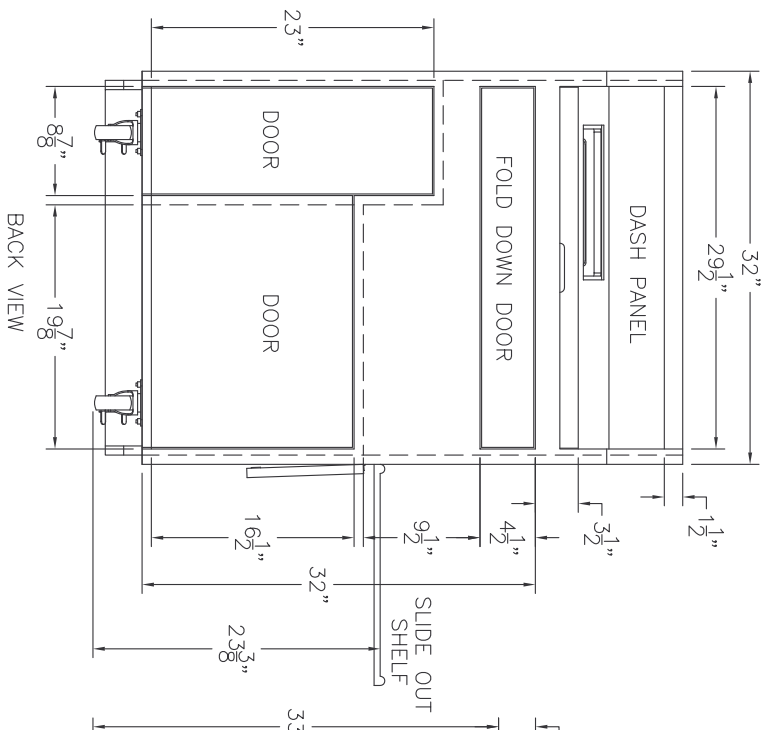
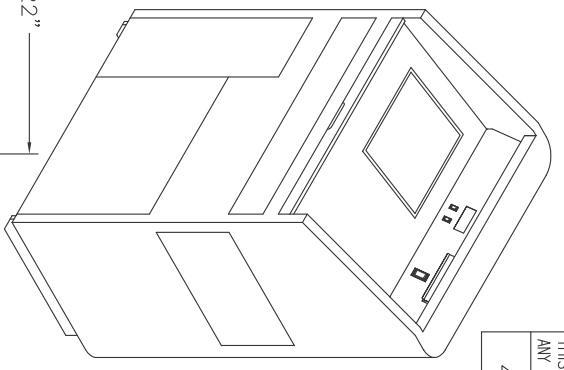
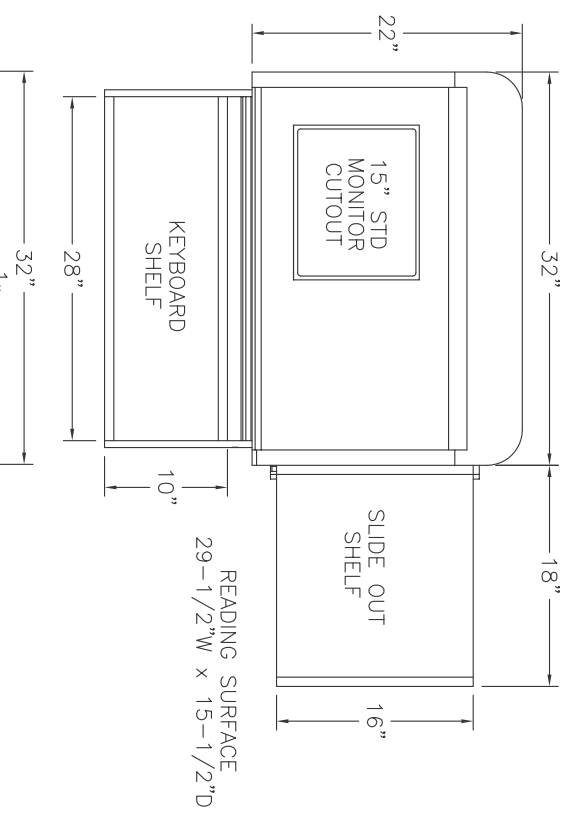

REVISION				
REVISED BY:				
APP'D BY:				
NAME: CONCORD 32" MULTI-MEDIA LECTERN DA-LITE SCREEN CO. NO: WARSAW, INDIANA, USA				
SCALE: 1=16	DRAWN BY: K.J.L.	DATE: 4-24-06	APP'D BY:	DATE:
MATERIAL NO: N/A	FINISH: N/A			CAD

THIS PRINT SUPERSEDES: NO:
 ANY PRINT DATED PRIOR TO:
 4-24-06

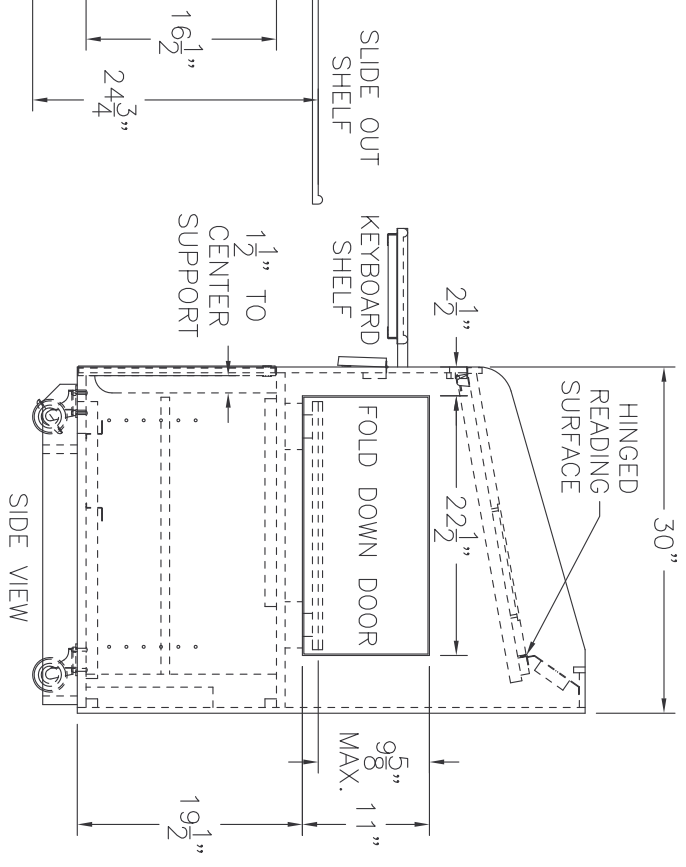
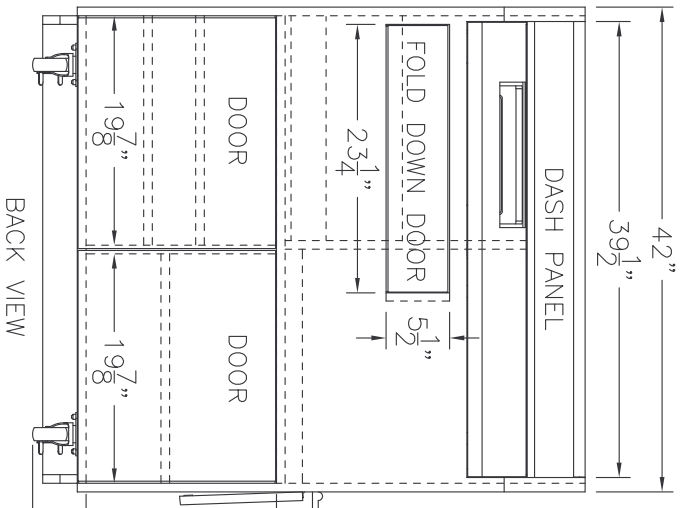
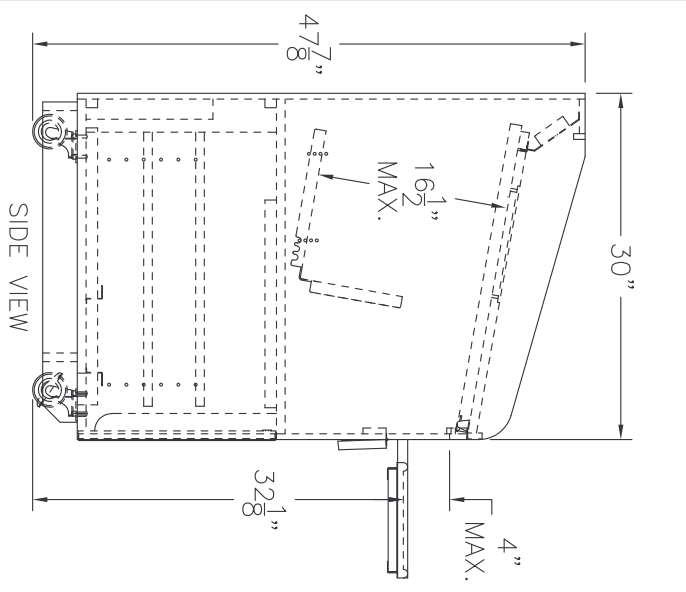
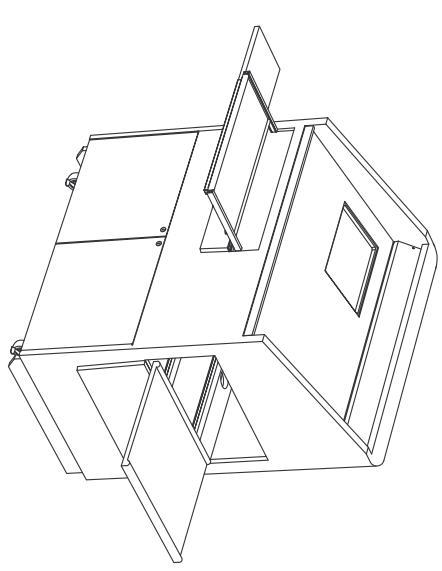
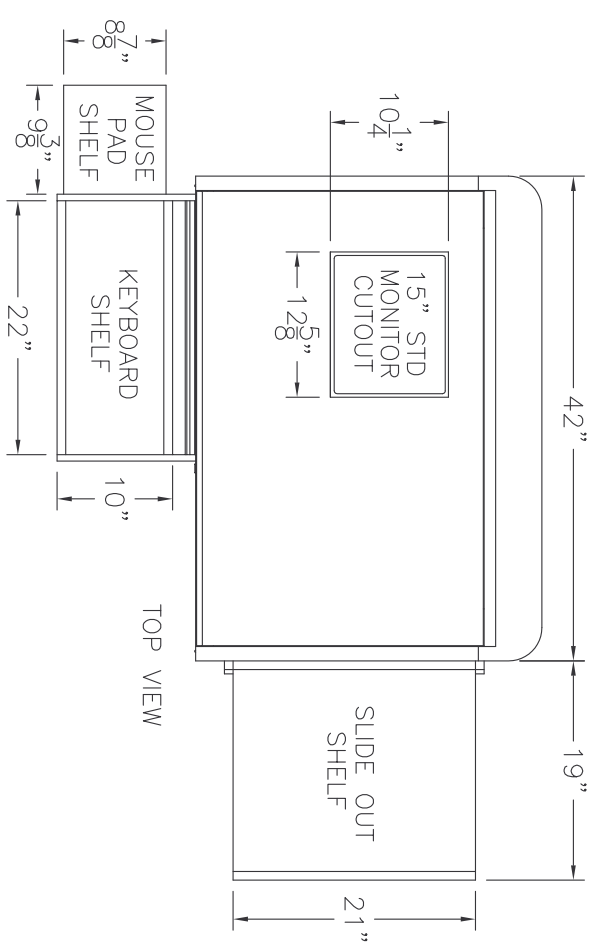

REVISION									
REVISED BY:									
APP'D BY:									
SCALE:	1 = 1/17	DRAWN BY:	K.J.L.	DATE:	4-24-06	APP'D BY:		DATE:	
NAME:	CONCORD 42" MULTI-MEDIA LECTERN								CAD
	DA-LITE SCREEN CO. INC.								NO:
	WARSAW, INDIANA, USA								